

Robust 140V V_{IN} , 400mA Step-Down Regulator for Industrial, Telecom and Automotive Environments

Design Note 543

Mike Shriver

The **LTC[®]7138** is a 400mA step-down regulator that can operate over an input voltage range of 4V to 140V, ideal for industrial, telecom, automotive and other applications subject to harsh line transients. Due to the regulator's hysteretic architecture, no external compensation is required. The output voltage is pin-programmable to 1.8V, 3.3V or 5.0V, or if an external divider is used, the output can be adjusted from 0.8V to V_{IN} . 100% duty cycle operation is possible because of the internal P-channel FET. The LTC7138 is offered in a thermally enhanced high voltage (skipped pins) MSOP package.

Simple 5V/400mA Buck with Wide V_{IN} Range

Figure 1 shows a 5V buck converter with a maximum input voltage of 140V using only four external components. Its output is set to 5V by tying the V_{PRG1} pin to the SS pin and the V_{PRG2} pin to ground. It does not require any external compensation.

Efficiency remains high over a broad range of loads due in part to the LTC7138's Burst Mode[®] operation and 12 μ A no load I_Q current. For a 12V input, efficiency peaks at 87% for a load of 10mA and stays above 80% for loads down to 0.4mA. This level of energy conservation makes it ideal for always-on battery operated systems.

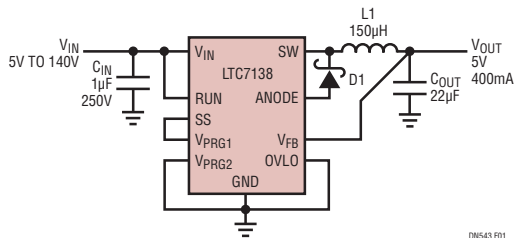

Figure 1. High Efficiency 5V, 400mA Buck Regulator

24V/800mA Buck Using Two LTC7138s in Parallel

Figure 3 shows two LTC7138s paralleled to provide an output of 24V at 800mA. Parallel operation is implemented by tying the feedback comparator output pin (FBO) of the master to the V_{FB} pin of the slave. In this setup, the slave follows the master as it enters and exits the burst cycles (see Figure 4). The output of the 24V buck is set with an external feedback divider. The full load efficiency for this regulator is 93.6% for a 48V input (Figure 5).

32V/400mA Surge Stopper

Figure 6 shows another use for the LTC7138. For inputs of 32V or below, this regulator operates in dropout, where the internal power FET is on continuously. When the input exceeds 32V, the LTC7138 switches to keep the output voltage in regulation, as shown in Figure 7. For further protection, an overvoltage lockout can be implemented by tying the OVLO pin to a divider across the input supply. This circuit is suitable for protecting downstream converters or loads in industrial, automotive or avionics systems.

 LT, LTC, LTM, Linear Technology, the Linear logo and Burst Mode are registered trademarks of Linear Technology Corporation. All other trademarks are the property of their respective owners.

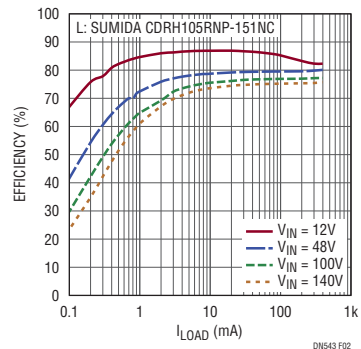

Figure 2. Efficiency of the Regulator in Figure 1

More Features

The LTC7138 provides additional features which makes it suitable for a wide array of applications. These include a RUN pin for an external UVLO, an ILIM pin for programming the current limit or setting up an input side current limit, and soft-start —either internal or external.

Conclusion

The LTC7138 yields low parts count, rugged solutions for wide input voltage applications. It features a 140V maximum input voltage rating, thermally enhanced high voltage MSOP package, Burst Mode operation, low I_Q current, pin adjustable output voltage, no external compensation and operation at 100% duty cycle.

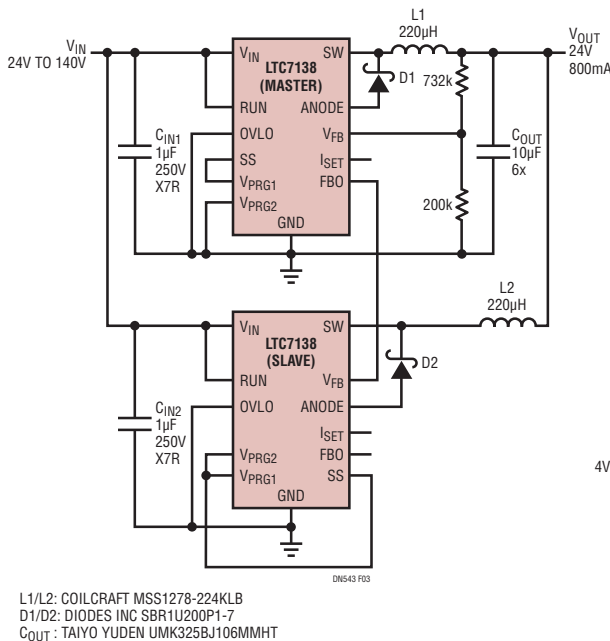

Figure 3. High Efficiency 24V, 800mA Buck Using Two LTC7138s in Parallel

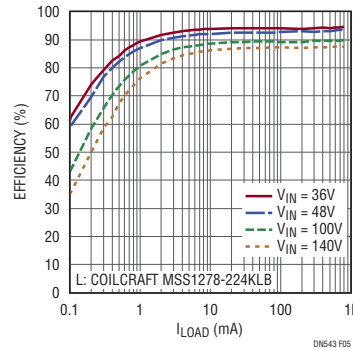

Figure 5. Efficiency of the Regulator in Figure 3

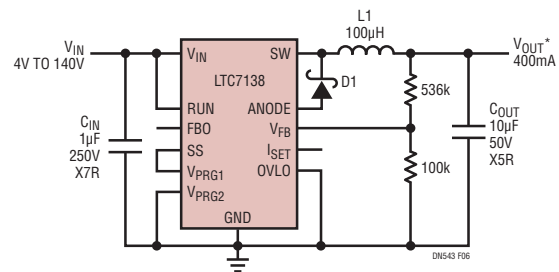

Figure 6. 32V, 400mA Surge Stopper
 * WHEN $V_{IN} > 32V$, LTC7138 SWITCHES AND V_{OUT} IS REGULATED TO 32V;
 WHEN $V_{IN} \leq 32V$, LTC7138 OPERATES IN DROPOUT AND V_{OUT} FOLLOWS V_{IN} .

Figure 7. Output of the Surge Stopper (Figure 6) Is Clamped to 32V During 127V Input Transient

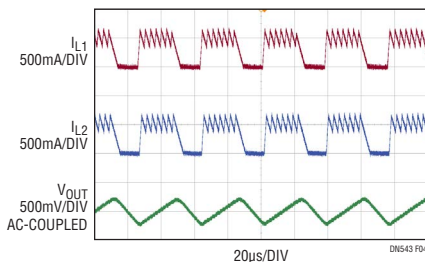

Figure 4. Parallel Operation of the 24V, 800mA Buck at $V_{IN} = 140V$, $I_{OUT} = 600mA$

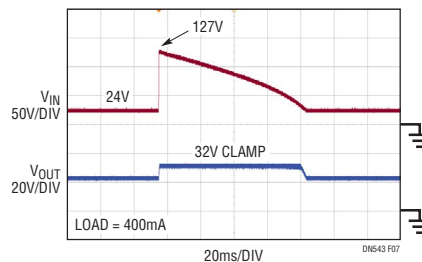

Figure 7. Output of the Surge Stopper (Figure 6) Is Clamped to 32V During 127V Input Transient

Data Sheet Download

www.linear.com/LTC7138

For applications help,
 call (408) 432-1900, Ext. 3720